

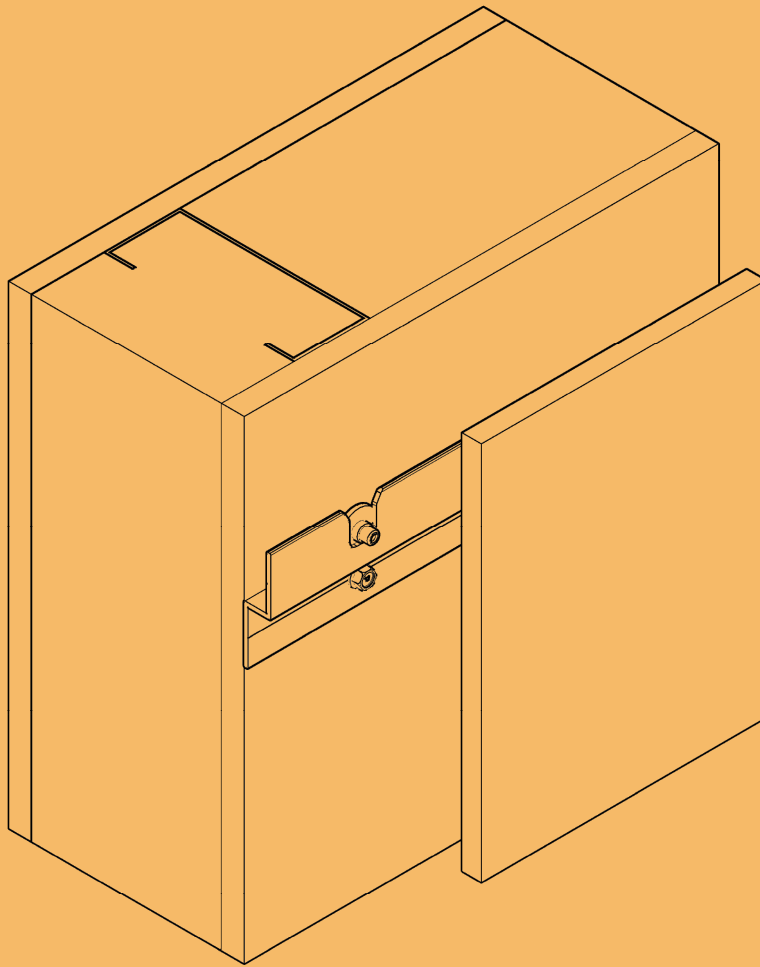

ALLFACE
Smart Fixing Systems



System TV800 for Trespa® Toplab® VERTICAL



Construction depth	2
Fixed / Sliding point	3-5
V1 – Top connection - front view	6
V2 – Top connection - back view	7
V3– Top connection - back view	8
V4– Bottom connection	9
V5– Bottom connection	10
H1 - Open connection	11
H2 - Tongue-and-groove connection	12
H3 - Halved joint connection	13
H4 - T-connection	14
H5 - Corner connection	15
H6 - Door-frame connection	16
H7 - Door-frame connection	17
H8 - Frame connection	18
V6 - Halved joint connection	19
V7 - Uneven walls	20
T1 - Requirement table	21
T2 - Requirement table	22
T3 - Requirement table	23
T4 - Requirement table	24
T5 - Requirement table	25
T6 - Requirement table	26

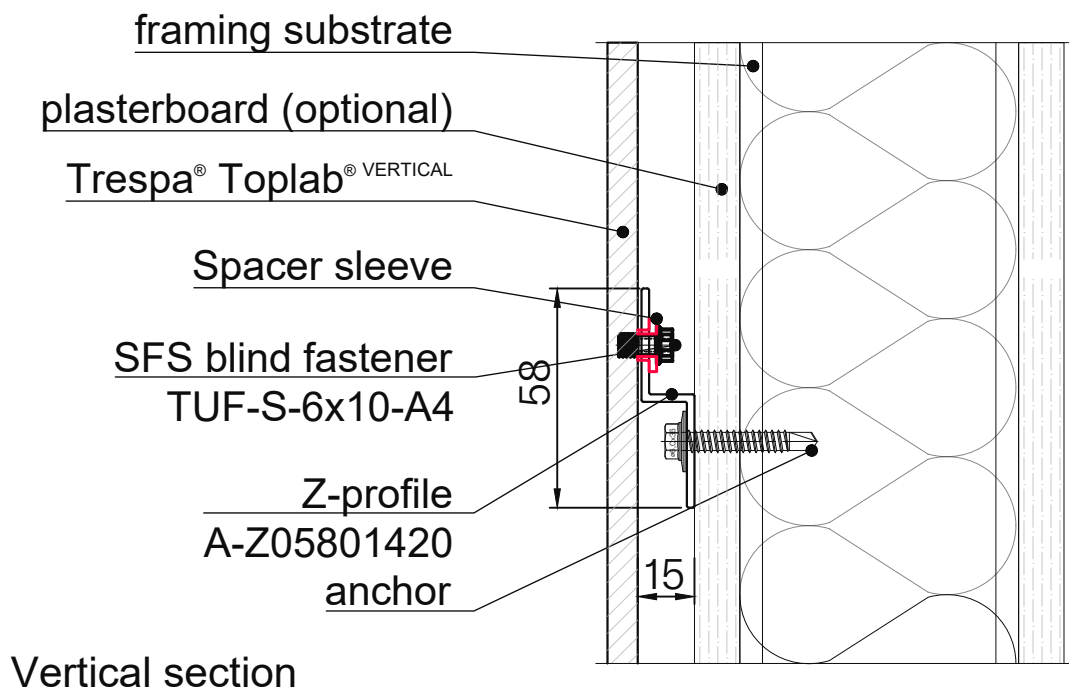
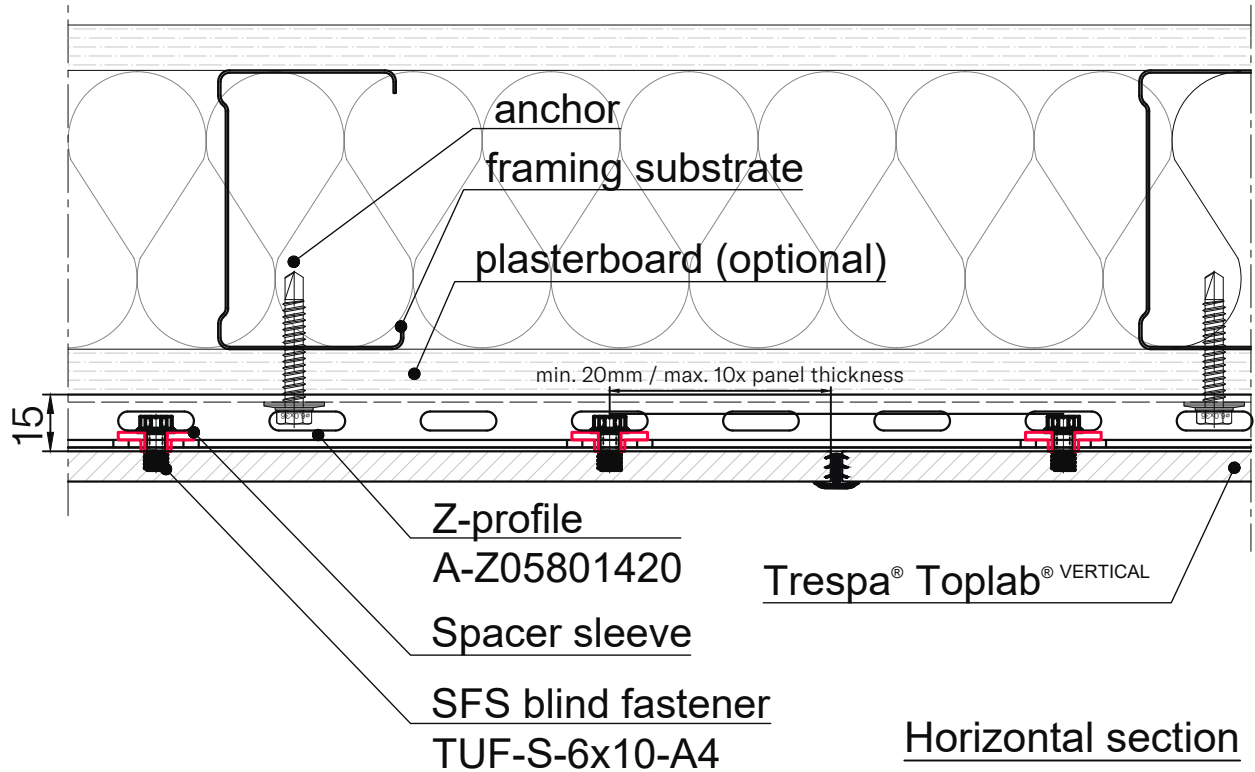

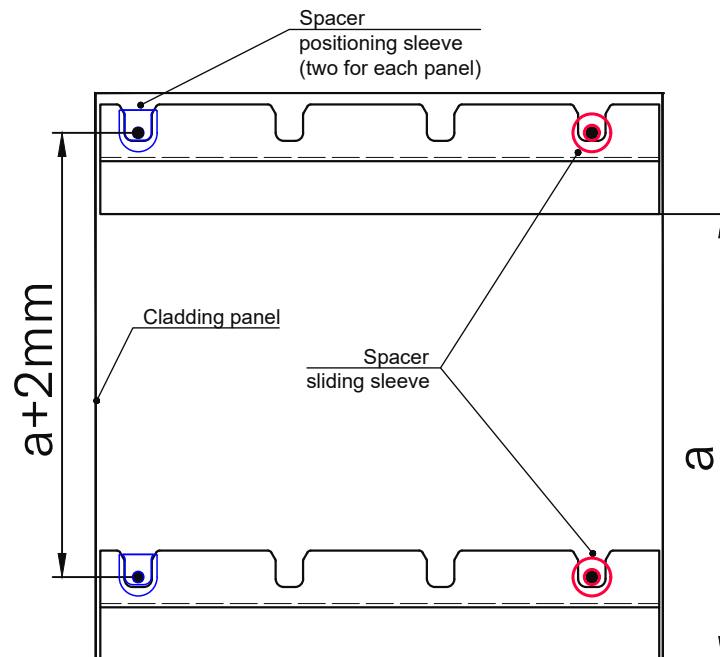
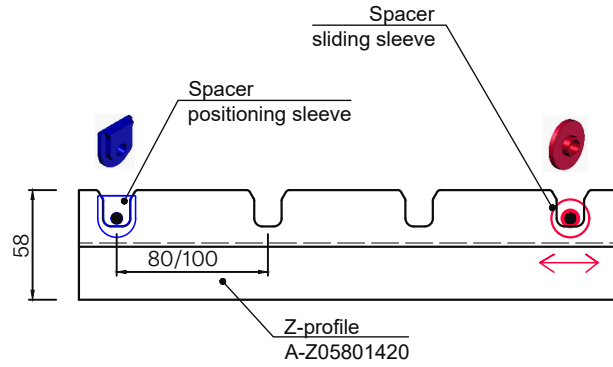

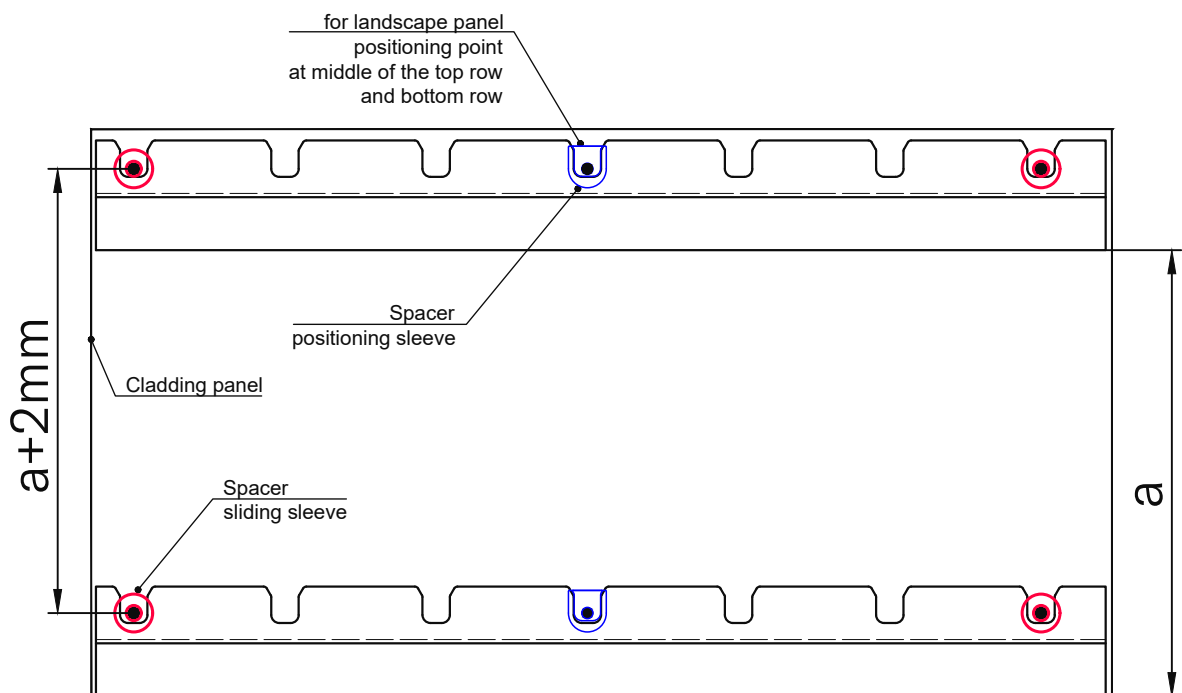
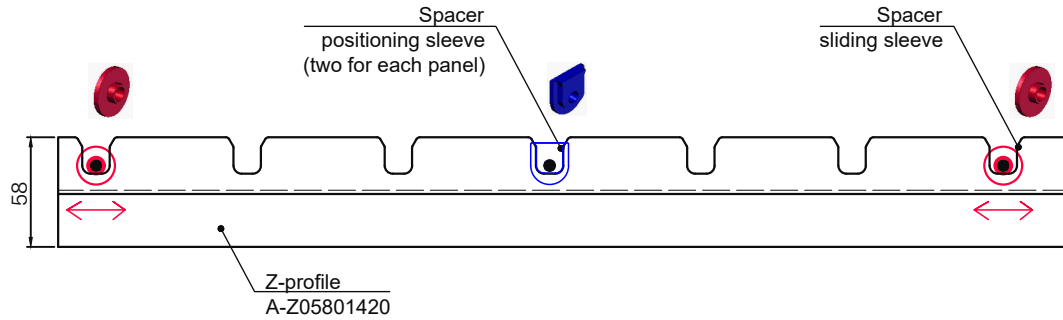

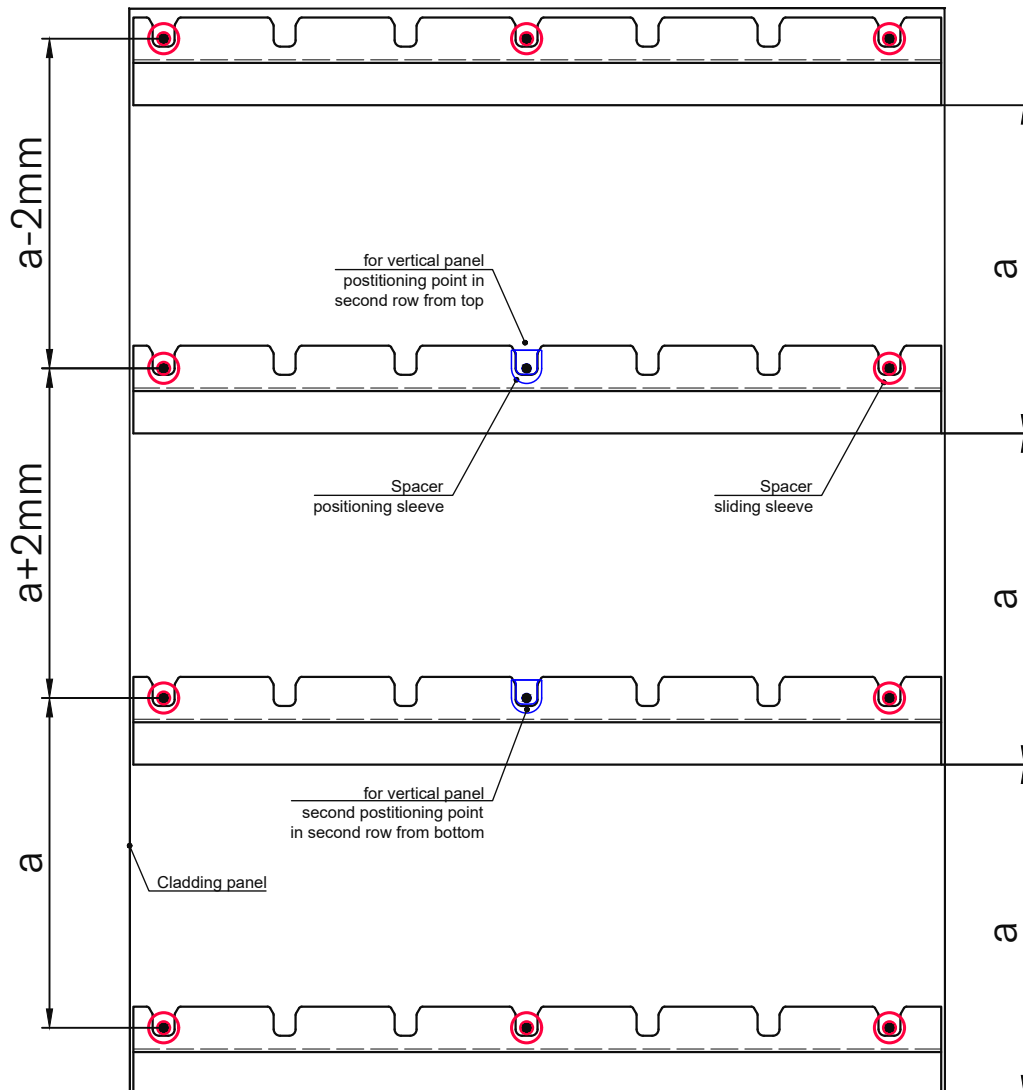
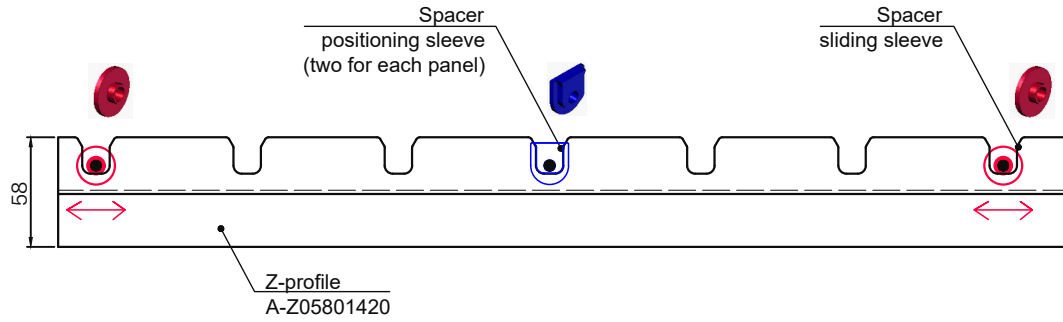

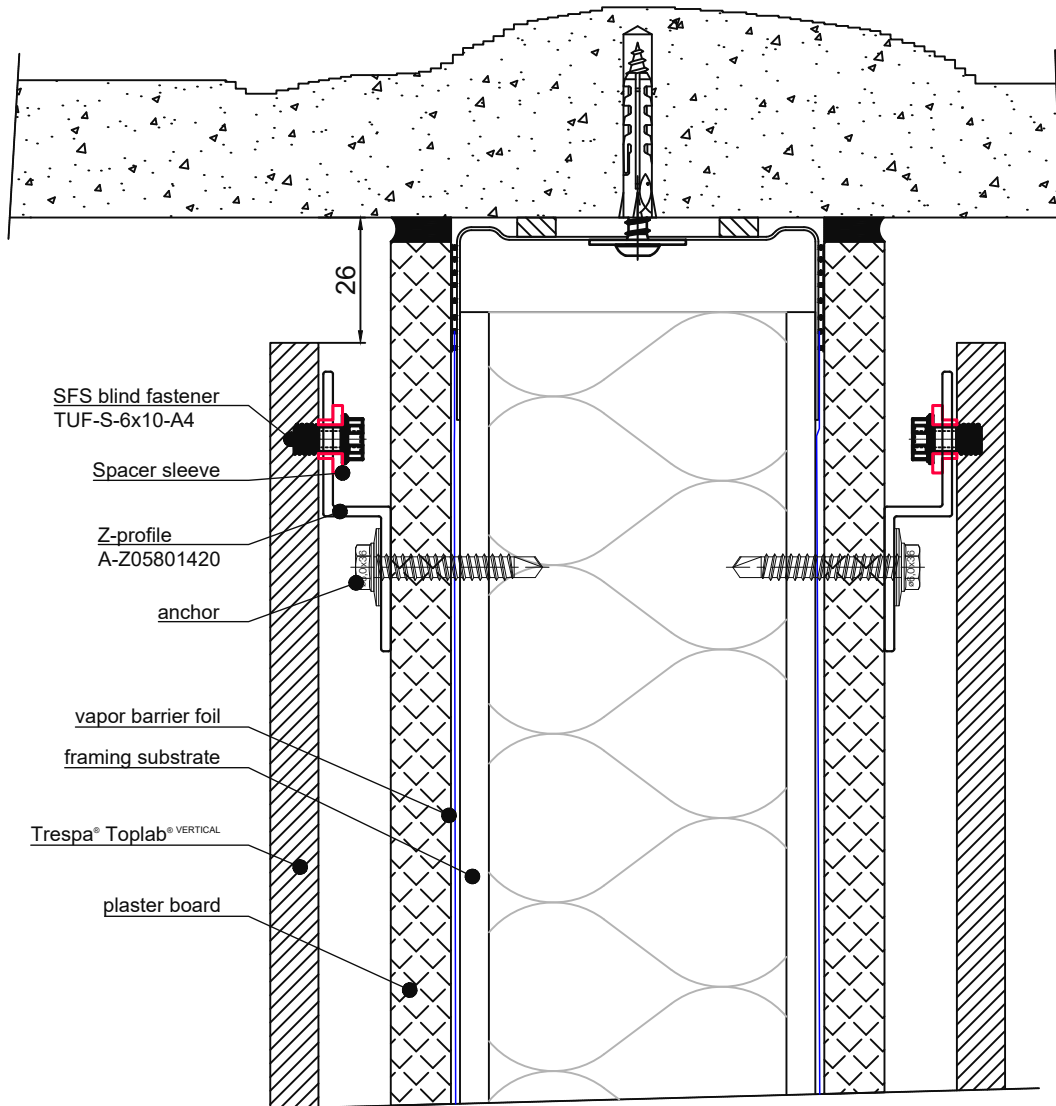

Vertical section

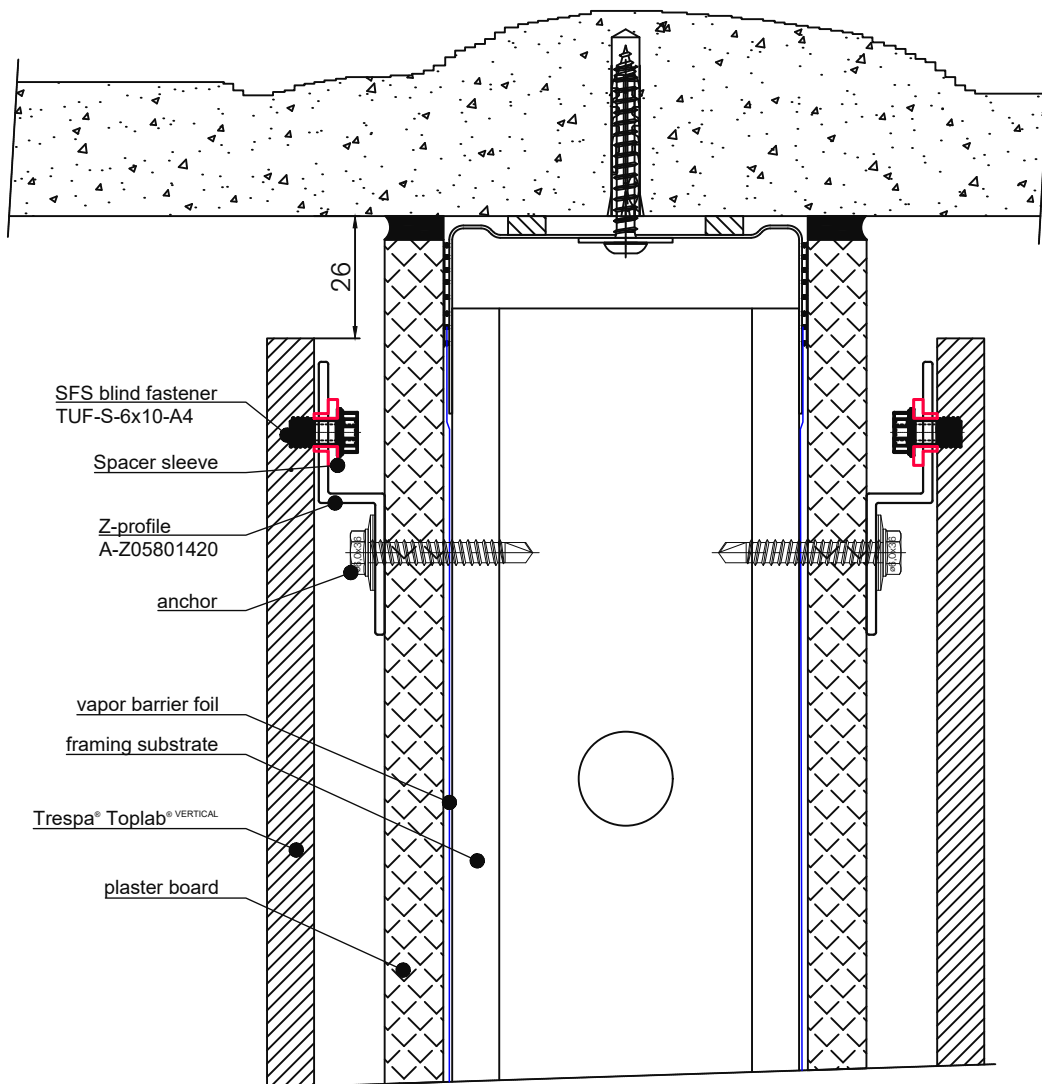

Vertical section

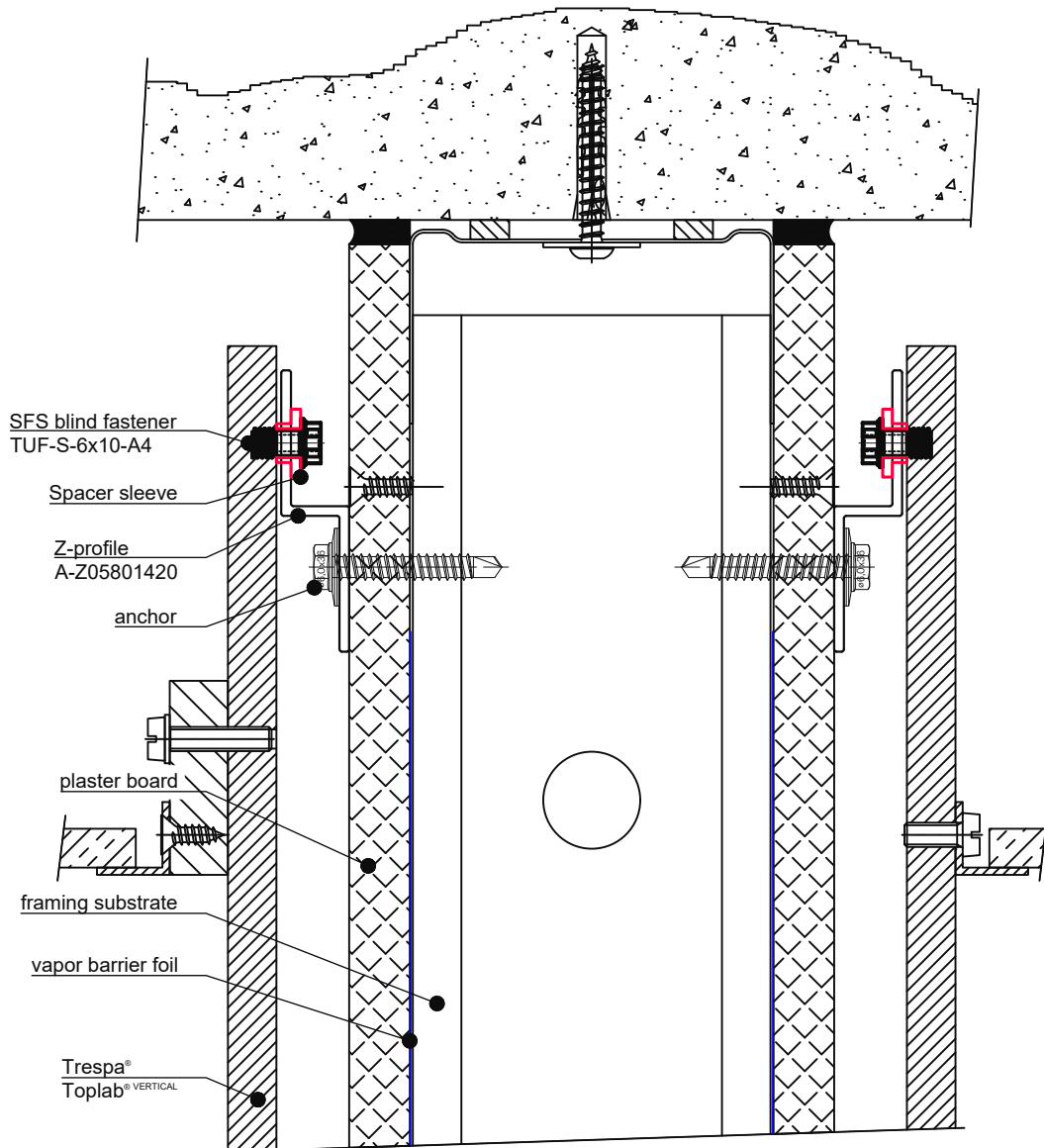

Vertical section

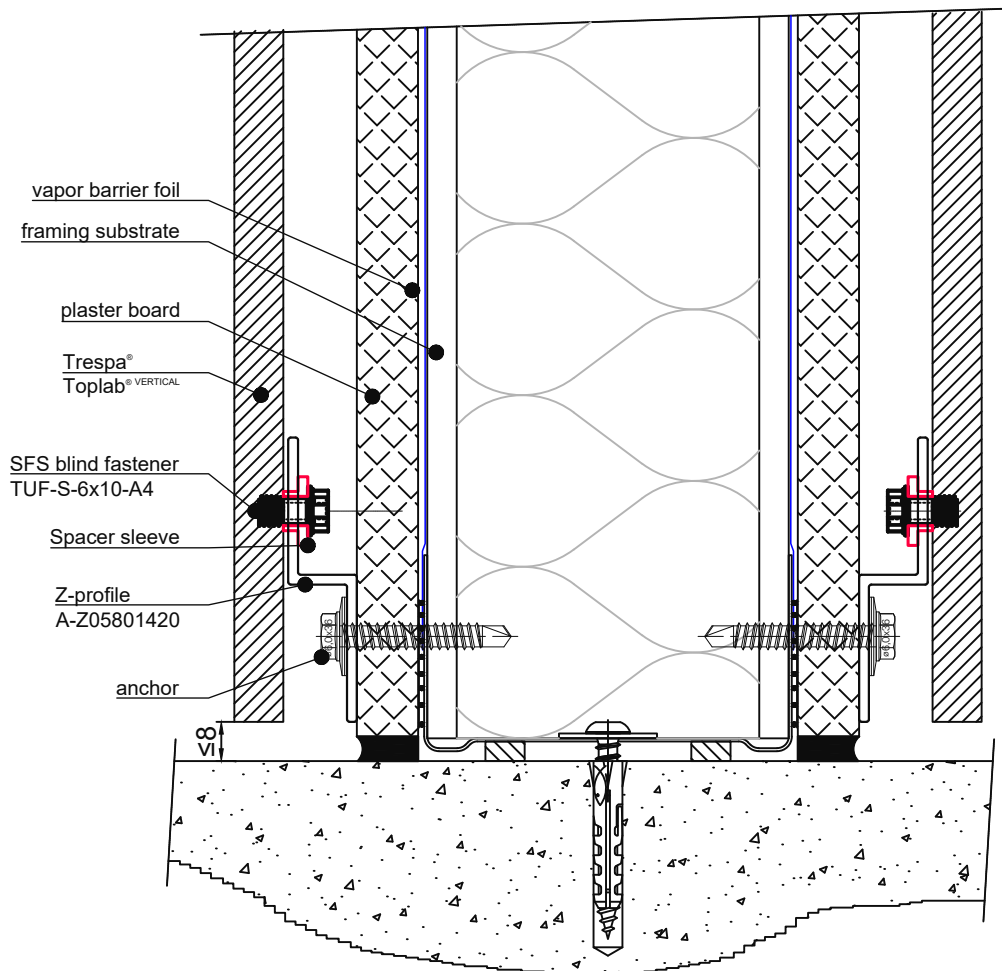

Vertical section

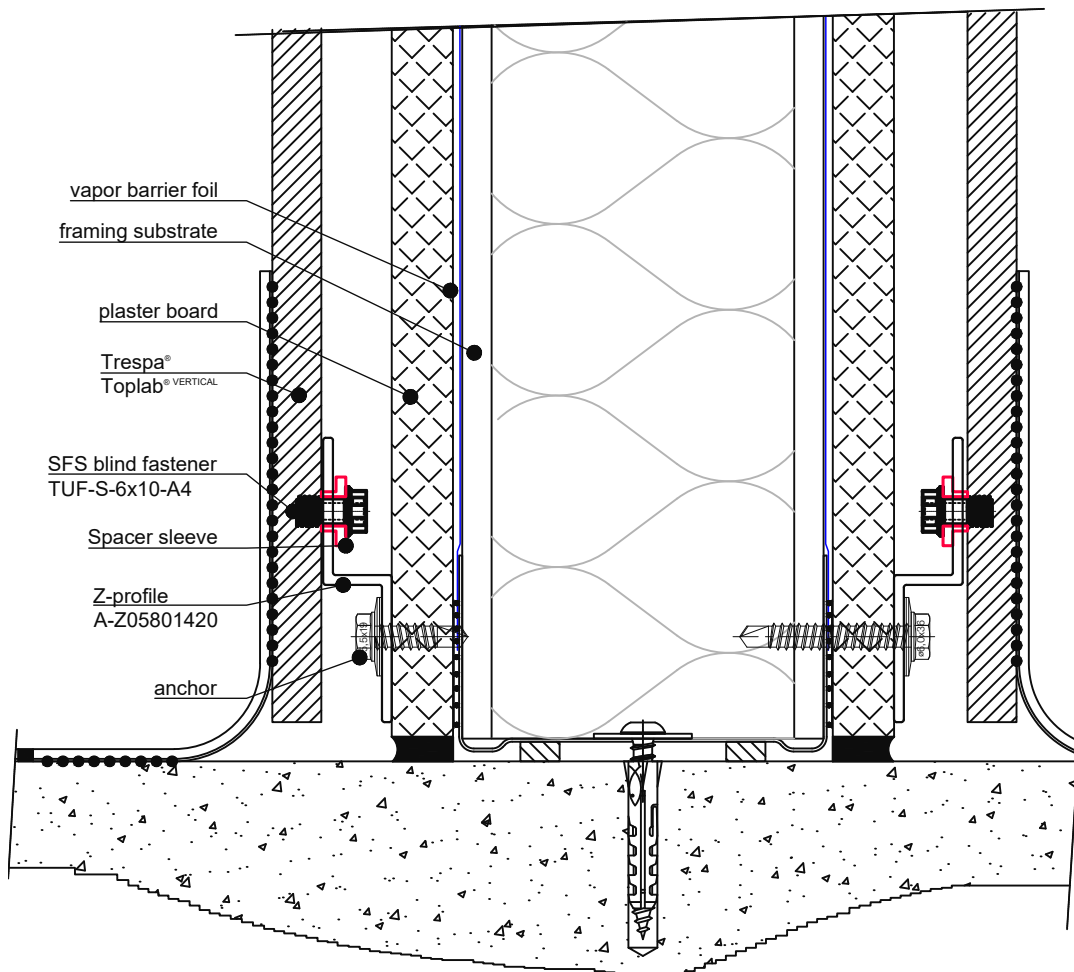

Vertical section

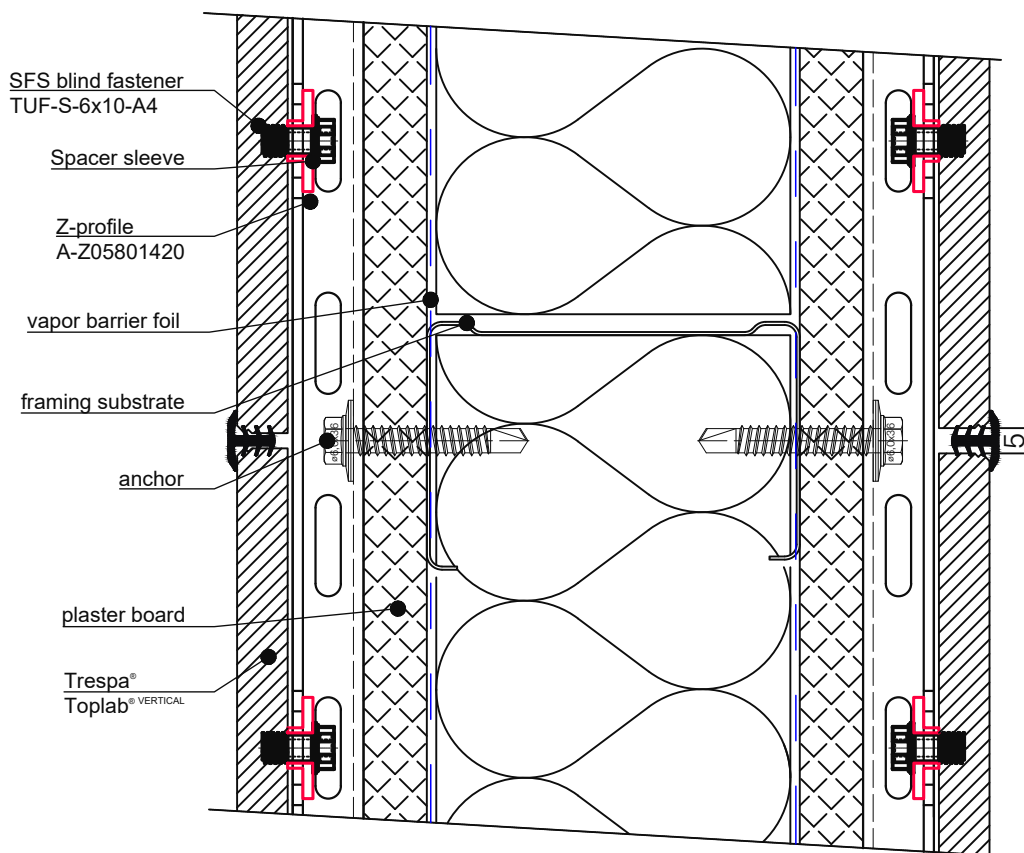

Horizontal section

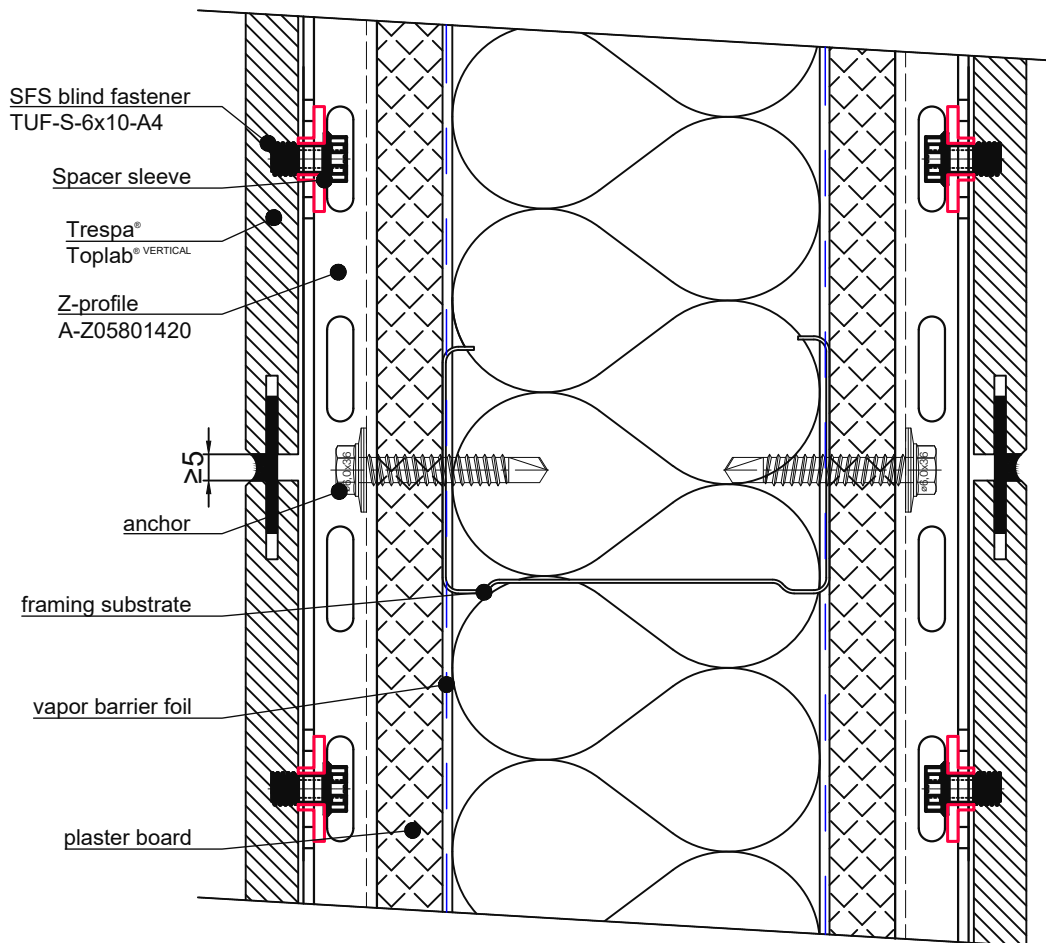

Horizontal section

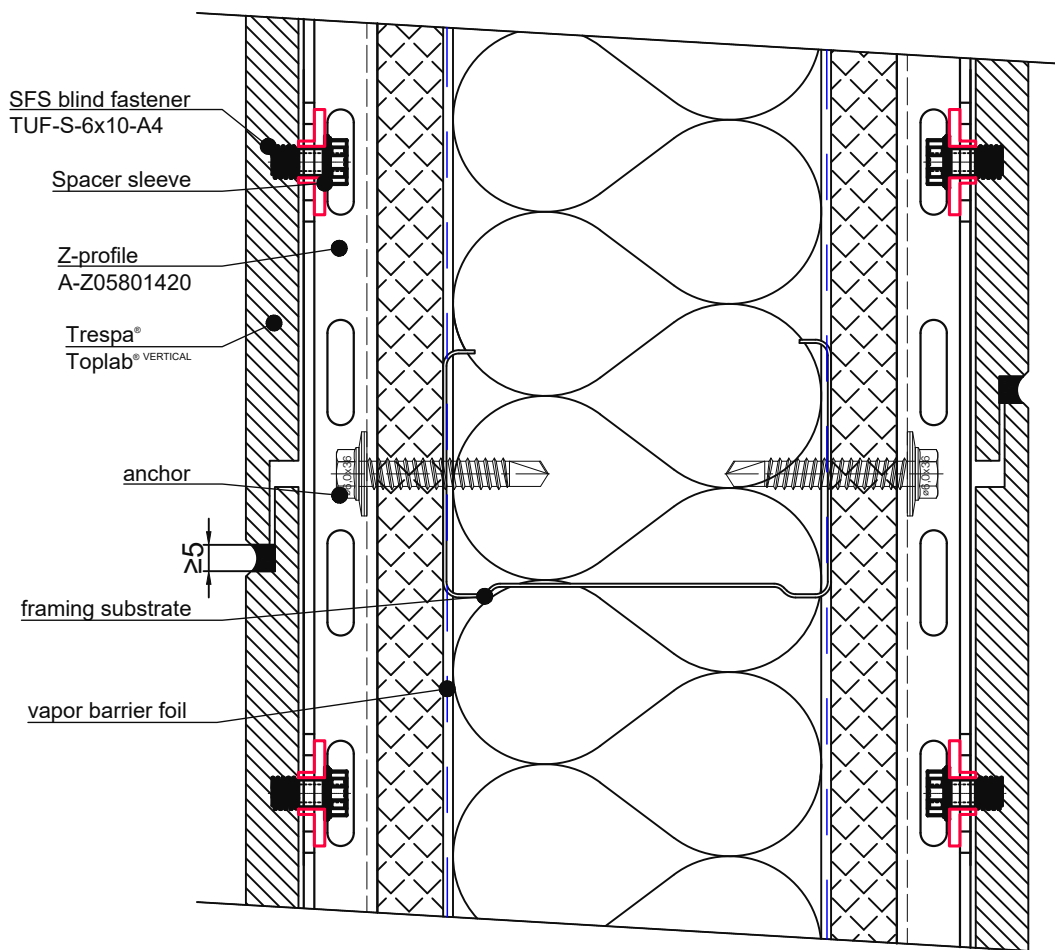

Horizontal section

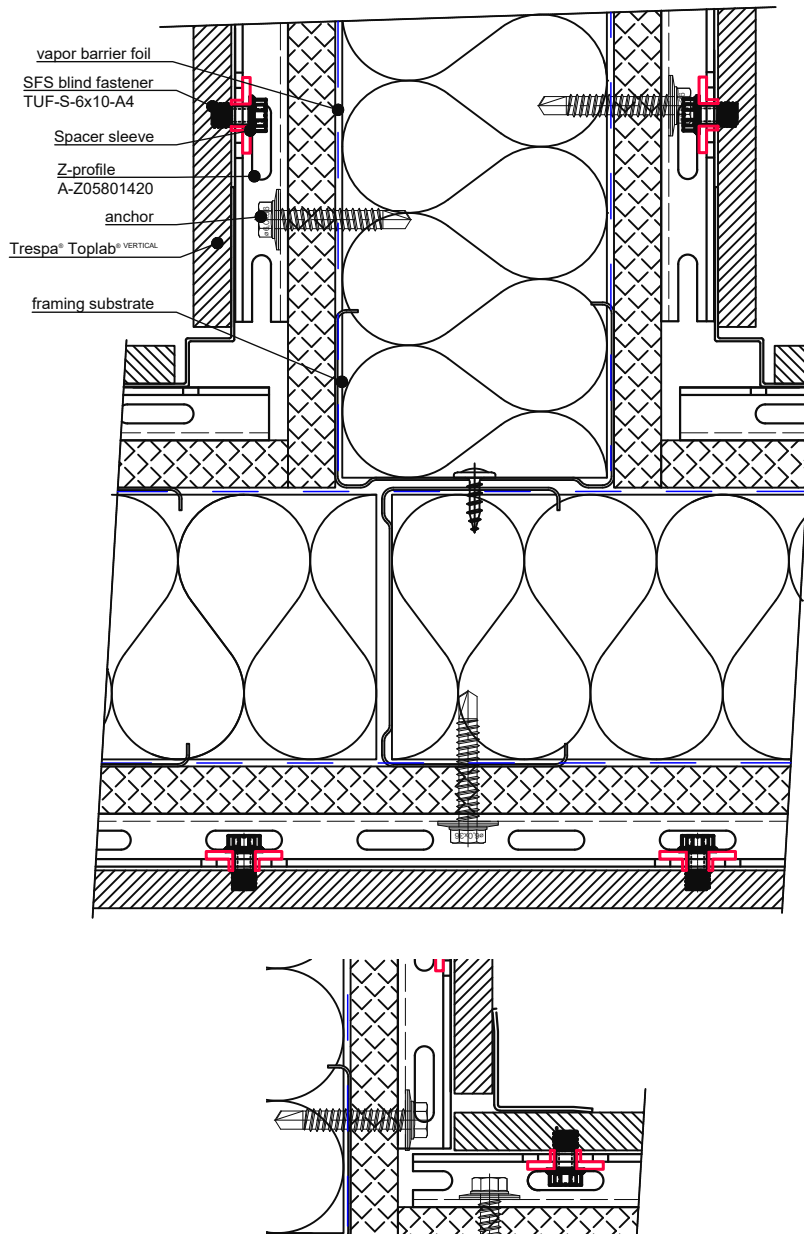

Horizontal section

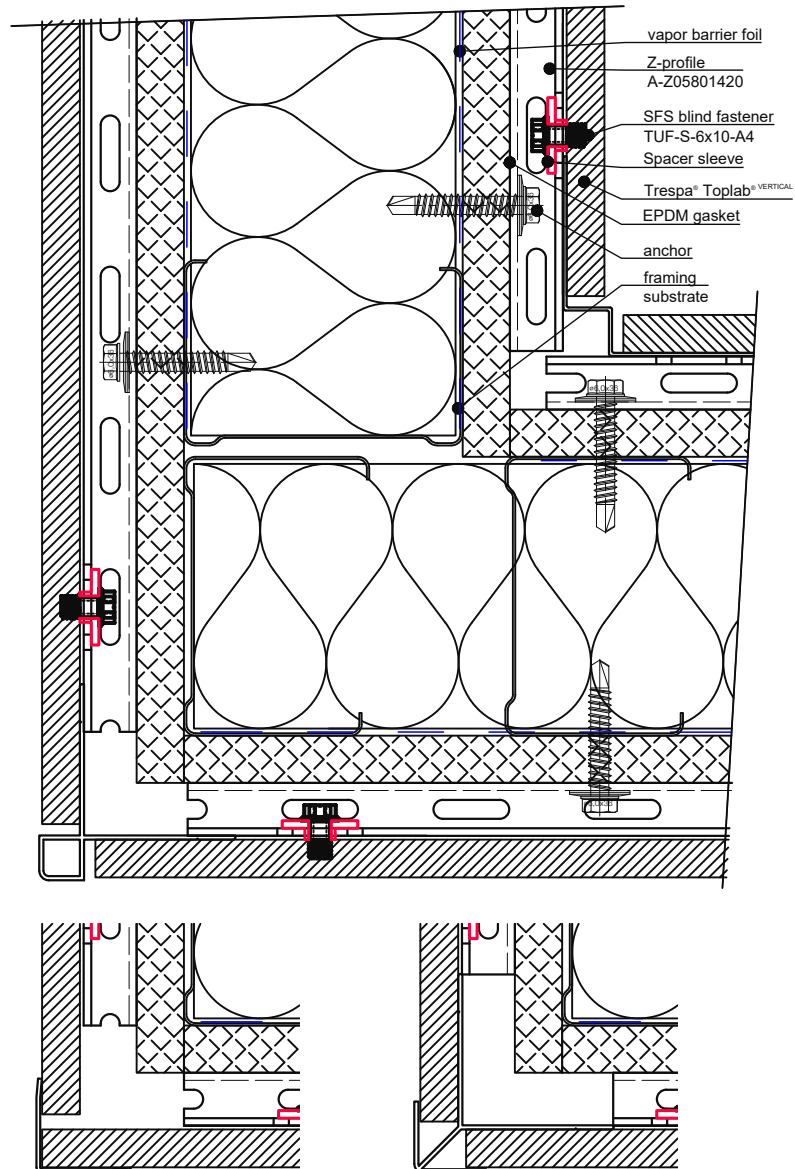

Horizontal section

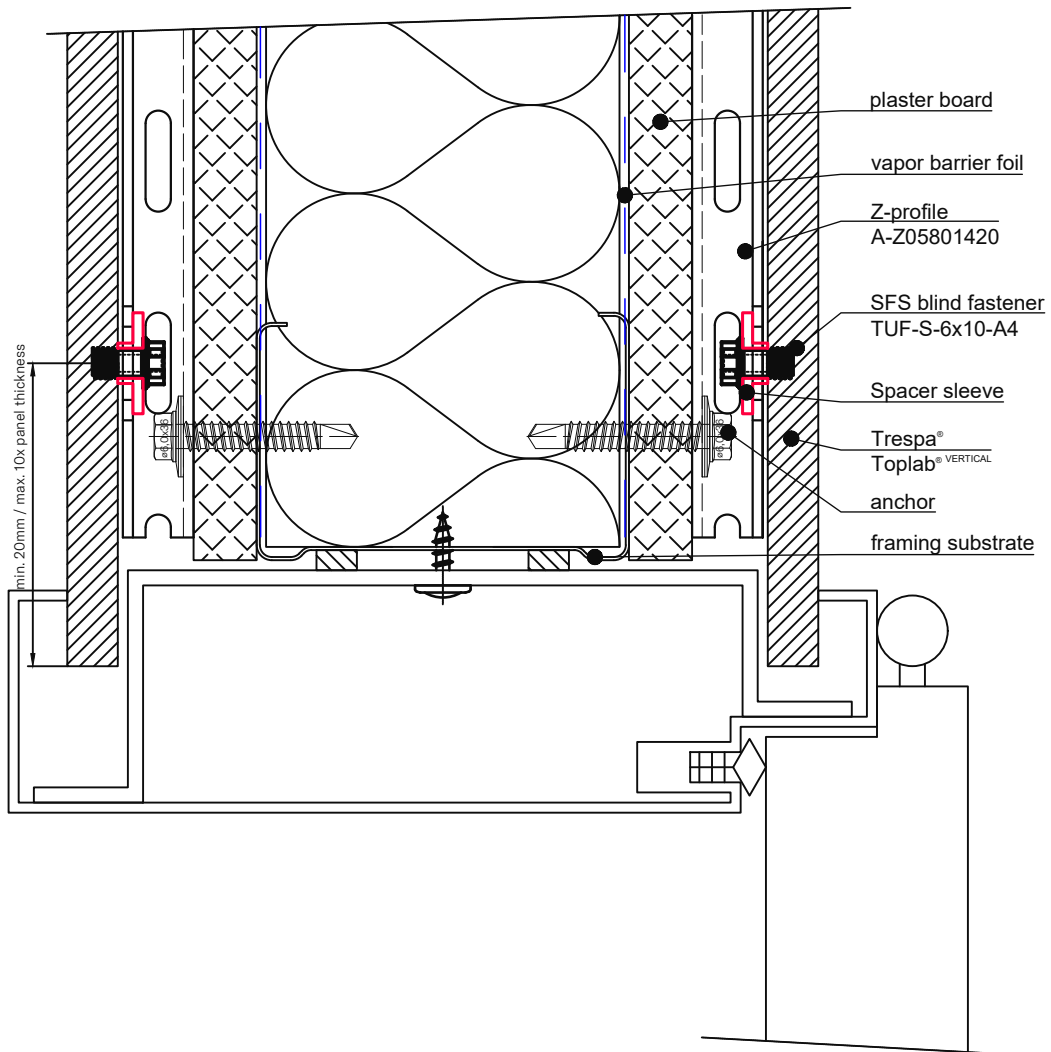

Horizontal section

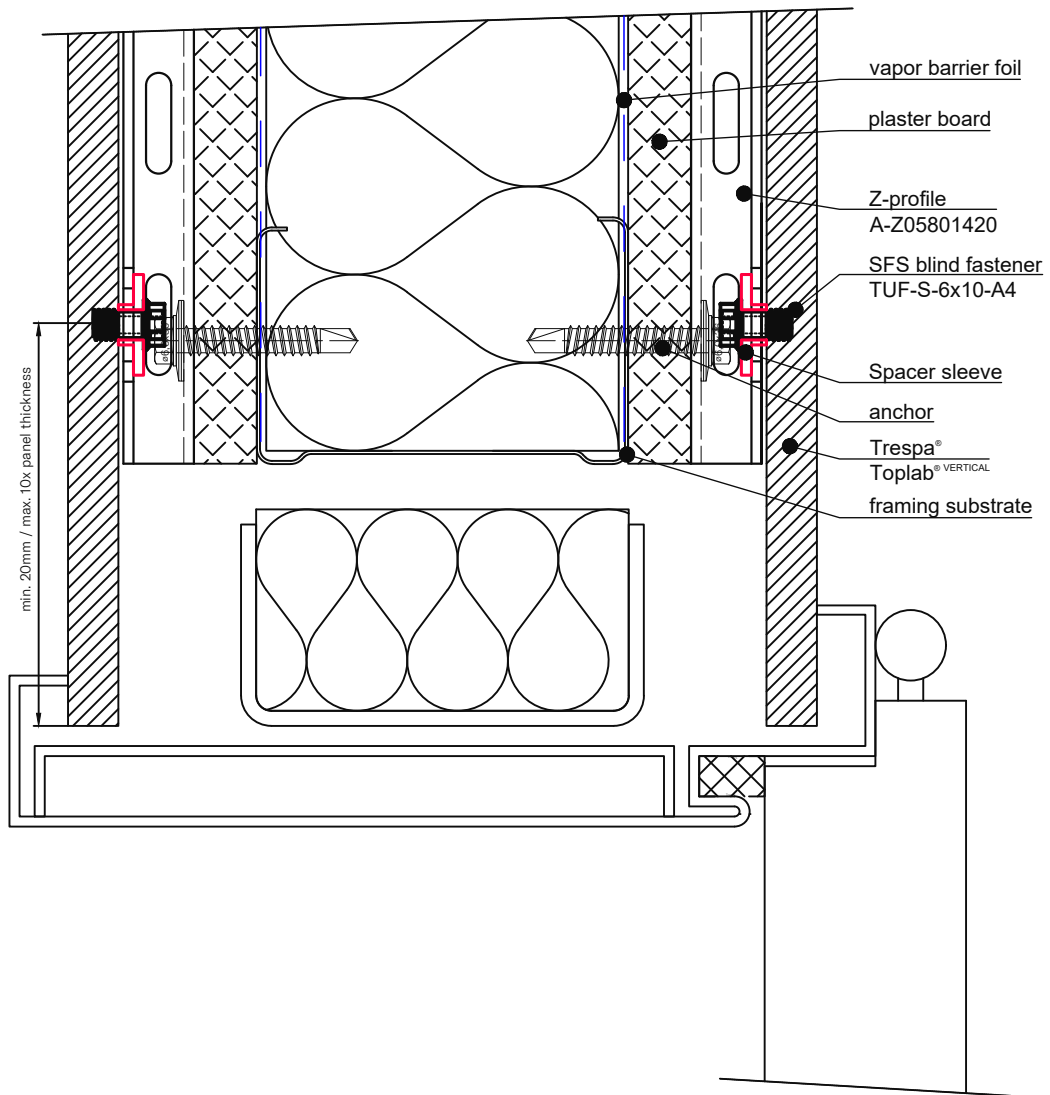

Horizontal section

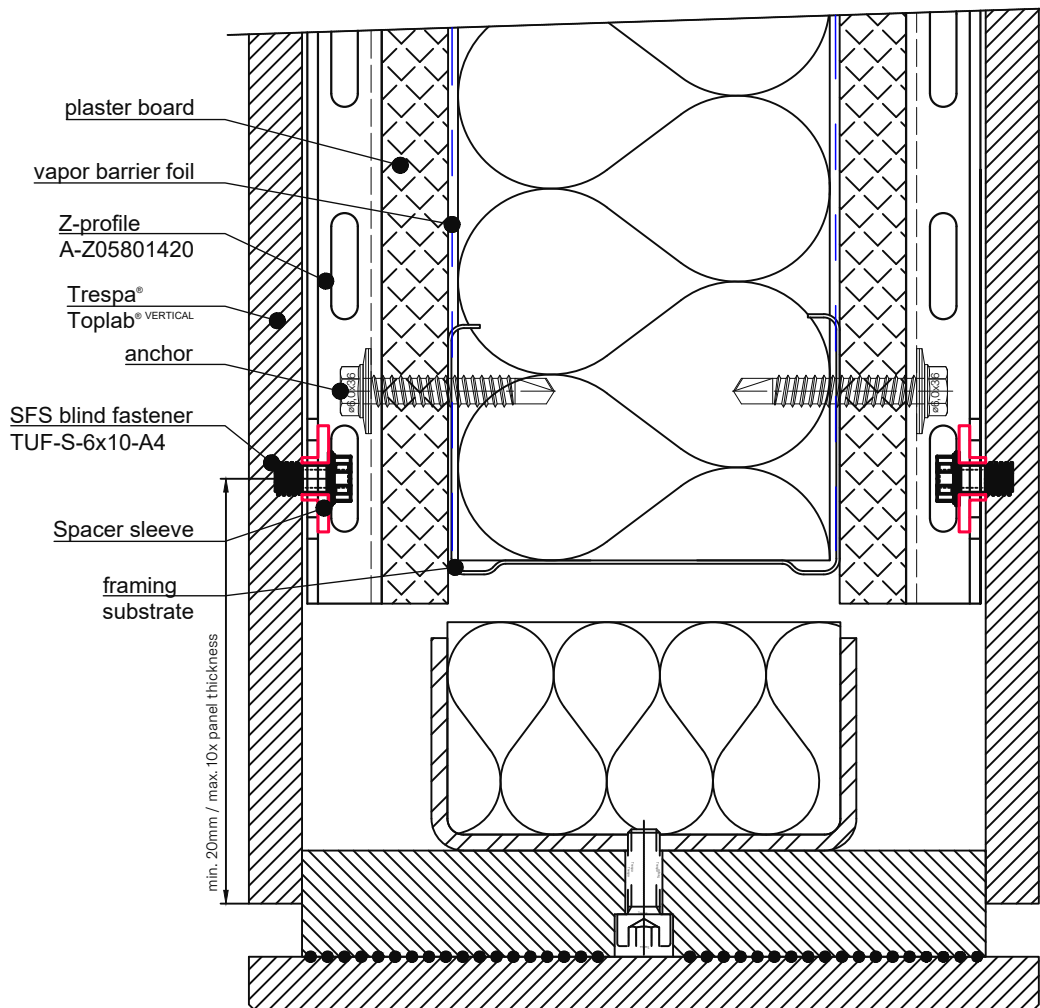

Horizontal section

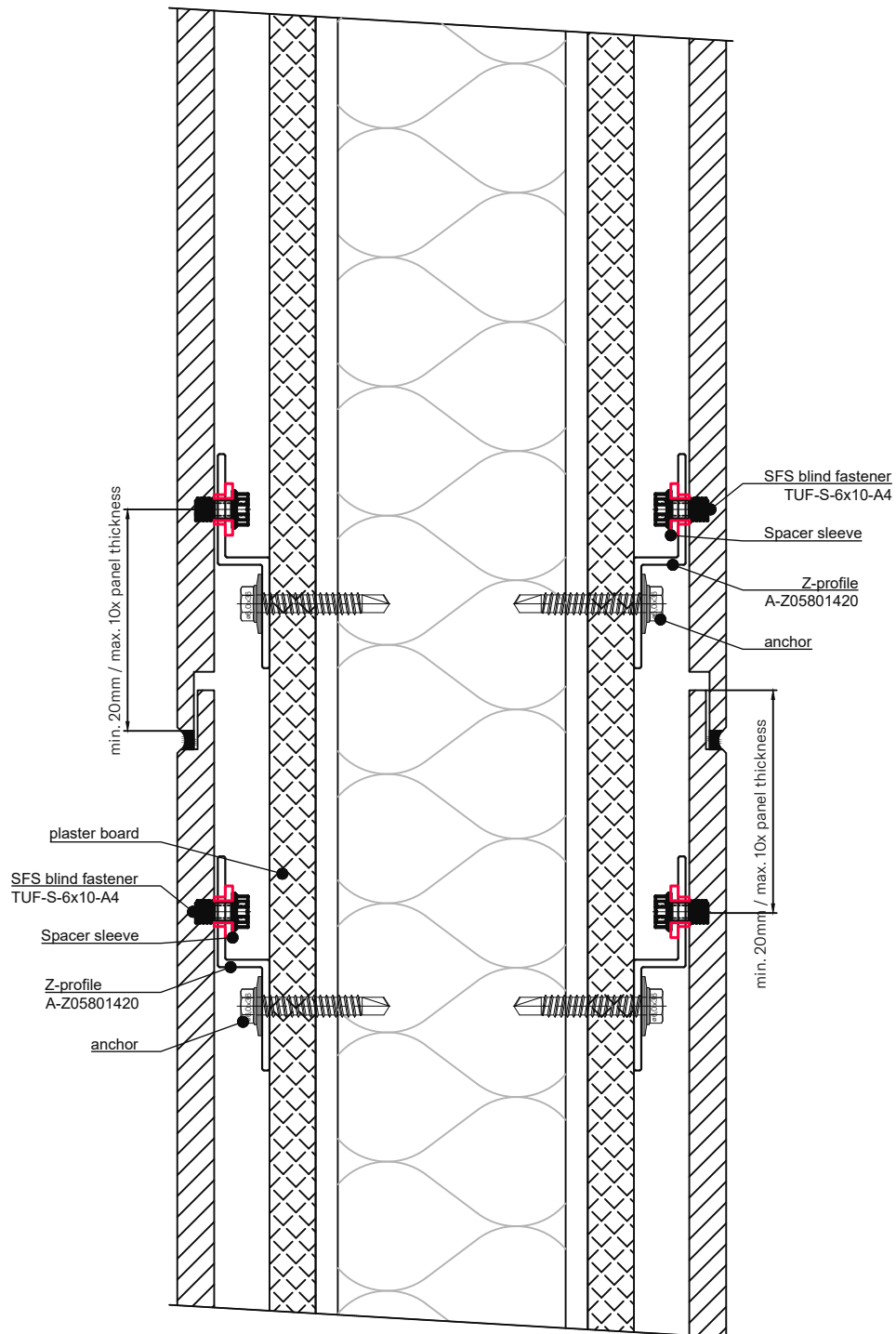

Vertical section

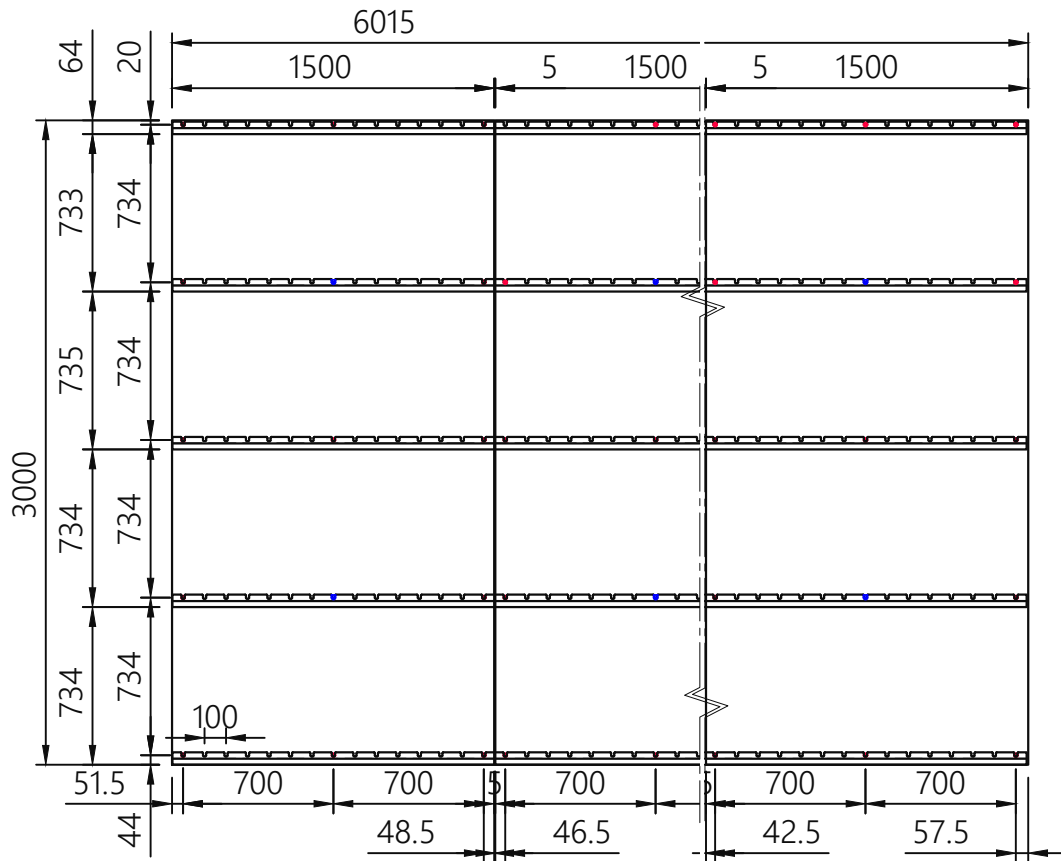

8mm panel thickness

8 pcs. spacer sleeve fixed point
50 pcs. spacer sleeve sliding point
58 pcs. TUF-S $\varnothing 6 \times 10$
10 pcs. Z-profile, length = 3 mtr.
~ 75 pcs. fixing screws

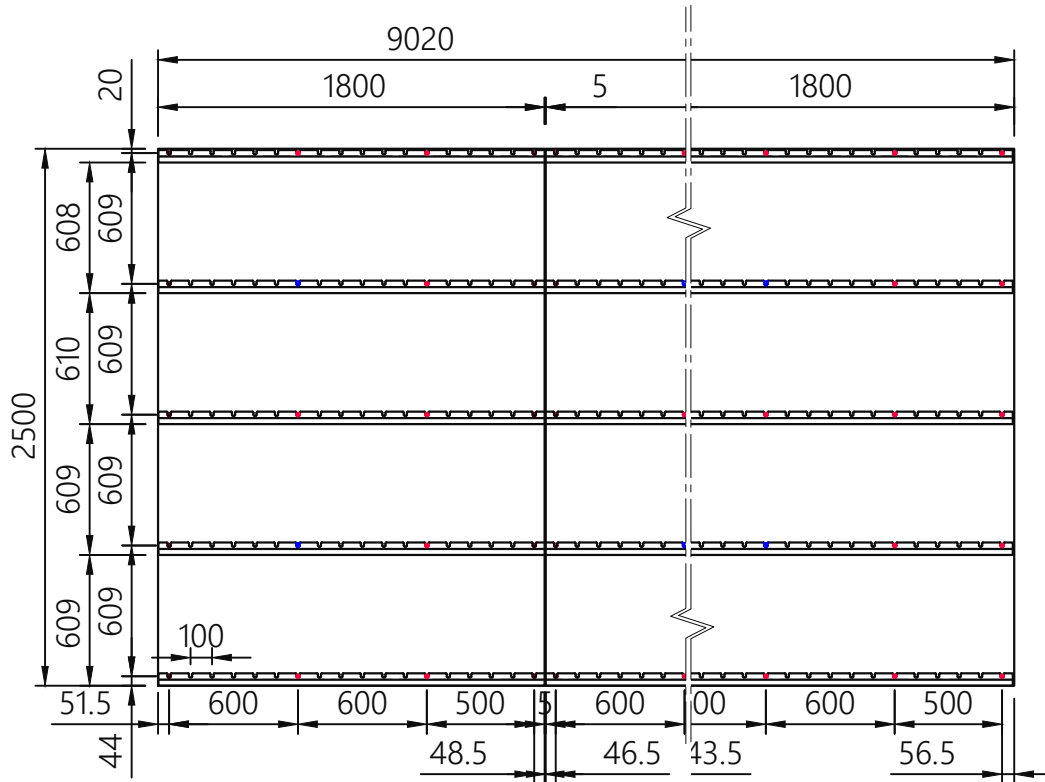

8mm panel thickness

10 pcs. spacer sleeve fixed point
90 pcs. spacer sleeve sliding point
100 pcs. TUF-S $\varnothing 6 \times 10$
15 pcs. Z-profile, length = 3 mtr.
~ 115 pcs. fixing screws

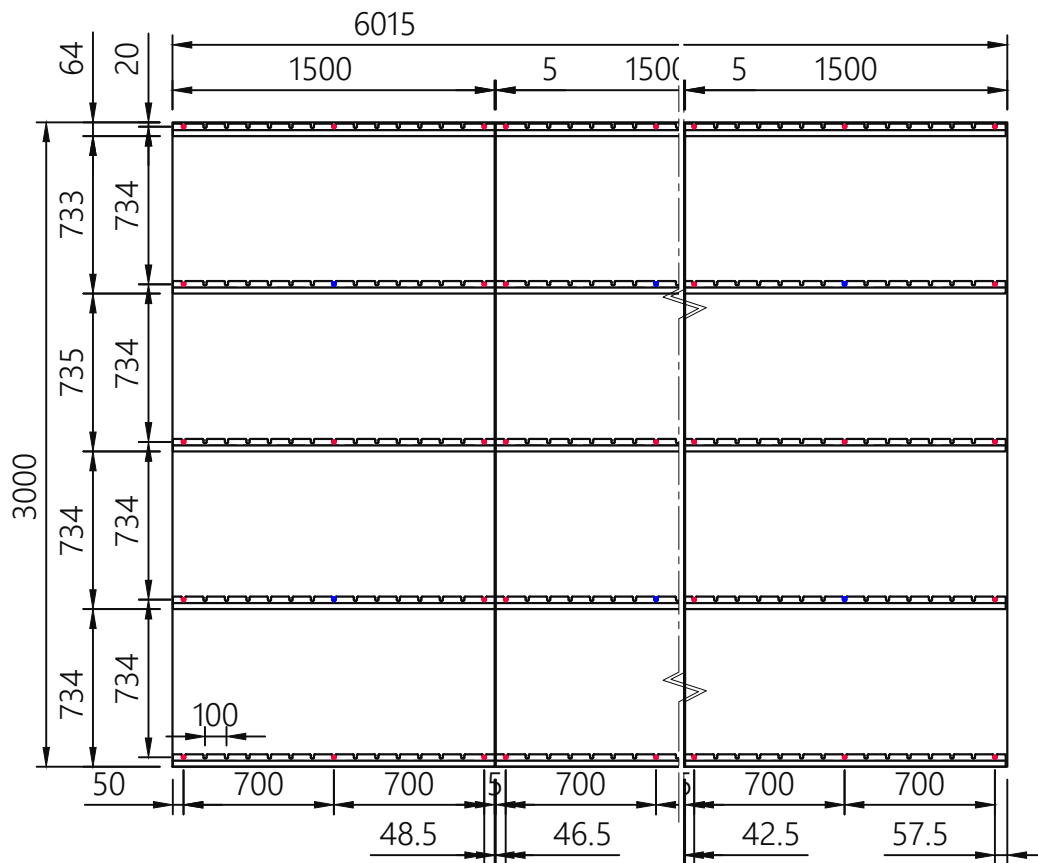

10mm panel thickness

8 pcs. spacer sleeve fixed point
50 pcs. spacer sleeve sliding point
58 pcs. TUF-S $\varnothing 6 \times 10$
10 pcs. Z-profile, length = 3 mtr.
~ 75 pcs. fixing screws

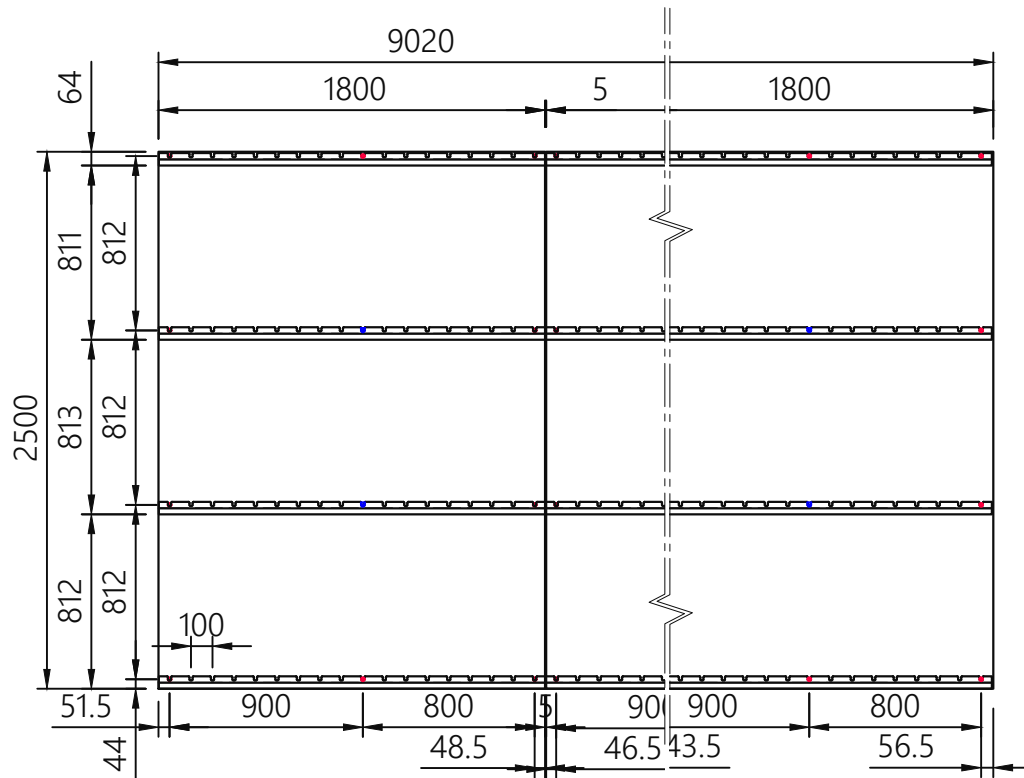

10mm panel thickness

10 pcs. spacer sleeve fixed point
50 pcs. spacer sleeve sliding point
60 pcs. TUF-S $\varnothing 6 \times 10$
12 pcs. Z-profile, length = 3 mtr.
~ 92 pcs. fixing screws

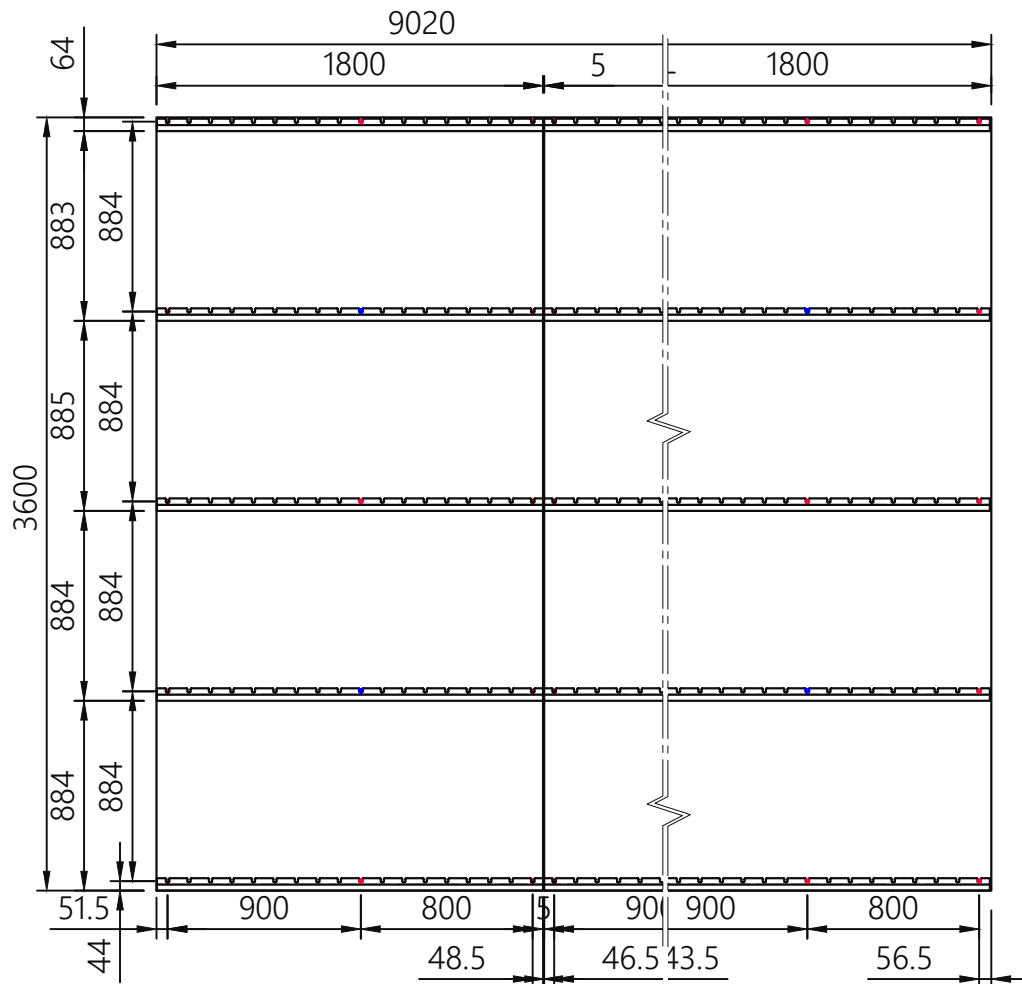

10mm panel thickness

10 pcs. spacer sleeve fixed point
65 pcs. spacer sleeve sliding point
75 pcs. TUF-S $\varnothing 6 \times 10$
15 pcs. Z-profile, length = 3 mtr.
~ 115 pcs. fixing screws